

# 14L3 Transducer



**LEGAL MANUFACTURER**

**BK Medical Aps**  
Mileparken 34  
2730 Herlev  
Denmark  
Tel.:+45 4452 8100/Fax:+45 4452 8199  
www.bkmedical.com  
Email: info@bkmedical.com

The connector label on a BK Medical transducer contains information about the date of manufacture.

**BK Medical Customer Satisfaction**

Input from our customers helps us improve our products and services. Your opinions are important to us. You are always welcome to contact us via your BK Medical representative or by contacting us directly.

**14L3 = Ref. Type 9051**

© 2020 BK Medical

Information in this document may be subject to change without notice.

# Contents

---

- Introduction . . . . . 5
  - Intended use . . . . . 5
  - Indications for Use . . . . . 5
- General Information . . . . . 6
  - Service and Repair . . . . . 6
  - Caring for the Transducer . . . . . 6
- Reprocessing . . . . . 6
- Starting Imaging . . . . . 7
  - Connecting the Transducer . . . . . 7
  - Changing Frequency . . . . . 7
  - Using a Transducer Cover . . . . . 7
  - Using the Transducer Control Button . . . . . 8
  - Changing Orientation . . . . . 8
- Puncture and Biopsy Facilities . . . . . 8
  - Single-Use Sterile Needle Guide UA1338 for 14L3 . . . . . 8
- Assembling and Mounting the Needle Guide . . . . . 11
- Performing Puncture and Biopsy . . . . . 12
  - Releasing the Needle During Biopsy . . . . . 13
  - Cleaning after Puncture and Biopsy . . . . . 13
- Disposal . . . . . 14



## Introduction

This is the user guide for the 14L3 transducer, and it must be used together with the *Care and Cleaning* user guide which contains important safety information.

 Physicians only	<b>Caution Rx-c1</b> United States Federal law restricts this device to sale by or on the order of a physician.
---	--

### Intended use

The transducer is intended for diagnostic ultrasound imaging or fluid flow analysis of the human body.

### Indications for Use

14L3 is suitable for small organ (small parts), musculoskeletal, pediatric, and peripheral vessel applications. It is also suitable for elastography<sup>1</sup> and vector flow imaging (VFI).

Needle guide UA1338 provides needle guidance for biopsy, catheter placement and drainage.

### Patient Population

The patient population is adults, adolescents, children and infants.





Figure 1. 14L3 transducer

1. Imaging mode is not available on the bkSpecto in Japan

## General Information

Product specifications, acoustic output data and data about EMC (electromagnetic compatibility) for this transducer can be found in the **Product Data Sheet** and the **Technical Data (BZ2100)** that accompany this user guide.

	<p><b>WARNING</b> GS-w2</p> <p>If at any time the system malfunctions, or the image is severely distorted or degraded, or you suspect in any way that the system is not functioning correctly:</p> <ul style="list-style-type: none"><li>• Remove all transducers from contact with the patient.</li><li>• Turn off the system. Unplug the system from the wall and make sure it cannot be used until it has been checked.</li><li>• Do not try to repair the system yourself.</li><li>• Contact your BK service representative or hospital technician.</li></ul>
---	---

	<p><b>WARNING</b> AO-w1</p> <p>To avoid tissue damage, always keep the exposure level (the acoustic output level and the exposure time) as low as possible.</p>
---	---

## Service and Repair

	<p><b>WARNING</b> SR-w1</p> <p>Service and repair of BK electromedical equipment must be carried out only by the manufacturer or BK authorized service representatives. BK Medical reserves the right to disclaim all responsibility, including but not limited to responsibility for the operating safety, reliability and performance of equipment serviced or repaired by other parties. After service or repairs have been carried out, a qualified electrician or hospital technician should verify the safety of all equipment.</p>
---	---

## Caring for the Transducer

The transducer may be damaged during use or reprocessing, so it must be checked before use for cracks or irregularities in the surface, following the procedure in **Care and Cleaning**. It should also be checked thoroughly once a month following the same procedure.

## Reprocessing

To ensure the best results when using BK Medical equipment, it is important to maintain a strict cleaning routine.

Complete details and procedures can be found in **Care and Cleaning** that accompanies this user guide.

A list of reprocessing methods that the transducer can withstand are listed in the **Product Data Sheet**.

Sterile covers are available. See the **Product Data Sheet** for more information.

	<p><b>WARNING</b> Reproc-w2</p> <p>Users of this equipment have an obligation and responsibility to provide the highest possible degree of infection control to patients, co-workers and themselves. The instructions in this book are meant as a guide. To avoid cross-contamination, follow all infection control policies (including for reprocessing, packing and storage) for personnel and equipment that have been established for your office, department or hospital.</p>
---	--

## Starting Imaging

Before use, all equipment must be reprocessed according to expected use.

	<p><b>WARNING</b> T-w5</p> <p>To prevent electrical shock and damage to the transducer, the connector pins in the transducer plug must always be completely dry before you connect to a system.</p>
---	---

## Connecting the Transducer

	<p><b>WARNING</b> GS-w4a</p> <p>It is essential for the patient's safety that only the correct equipment is used.</p> <ul style="list-style-type: none"> <li>• Do not use other manufacturers' transducers with BK ultrasound systems.</li> <li>• Do not use BK transducers with other manufacturers' systems.</li> <li>• Do not use unauthorized combinations of transducers and needle guides.</li> </ul>
---	---

The transducer is connected to the system using the array transducer socket on the system. To connect, flip the system's locking lever to the right. Align the transducer plug to the system socket and insert securely. Flip the system's locking lever to the left to lock it.

When connected, the transducer complies with Type BF requirements of EN60601-1 (IEC 60601-1).

## Changing Frequency

The multifrequency imaging (MFI) control enables you to select the imaging frequency. See the applicable system user guide for instructions.

## Using a Transducer Cover

BK recommends the use of a sterile transducer cover to reduce the risk of cross-contamination. See the **Product Data Sheet** for a list of available transducer covers. Follow local guidelines for the use of transducer covers in your area.

**NOTE:** *In the United States of America, it is recommended to use transducer covers that have been market cleared. In Canada, use only licensed transducer covers. In Europe, transducer covers must be CE-marked.*

**WARNING TC-w1**

Some transducer covers can contain latex. Because of reports of severe allergic reactions to medical devices containing latex (natural rubber), the FDA advises health-care professionals to identify their latex-sensitive patients and be prepared to treat allergic reactions promptly.

Apply sterile gel to the tip of the transducer or fill the cover with 1 to 2 ml of sterile water. This improves screen imaging by preventing image artifacts caused by air bubbles.

Gel also creates a good acoustic contact between the skin and the transducer; therefore, apply a small amount to the outside of the cover prior to imaging and re-apply frequently.

Follow these precautions when putting sterile covers on a transducer:

- Wear sterile gloves.
- When using a puncture attachment, place it gently over the cover and secure it, following the instructions for the puncture attachment.
- Verify that the cover has not been damaged in the process. If it has, repeat the procedure with a new transducer cover.

**Caution T-c3**

Use only water-based gel (sterile if you are using a sterile transducer cover). Products containing parabens, petroleum, or mineral oils may harm the transducer or transducer cover.

## Using the Transducer Control Button

The control button on the transducer controls the imaging.

Press the button to **Start** or **Stop** imaging (freeze frame). Press the button for more than one second to make a copy of the image.

## Changing Orientation

To change the orientation of the image on the monitor, refer to the applicable system user guide for instructions

## Puncture and Biopsy Facilities

The transducer can be used for puncture and biopsy. The appropriate puncture attachments are illustrated on the following pages with a brief description of their use and operating instructions.

## Single-Use Sterile Needle Guide UA1338 for 14L3

Needle guide UA1338 is supplied sterile in peel packs and is for single-use only. Contents are sterile only if the package is intact. The needle guide, inserts, and palettes must be discarded after use.



	<p><b>WARNING Sterile-w1</b></p> <p>Single-use components are packaged sterile and are intended for single-use only.</p> <p>Do not use if:</p> <ul style="list-style-type: none"> <li>• Integrity of packaging is violated</li> <li>• Expiration date has passed</li> <li>• Package label is missing</li> </ul>
---	---

	<p><b>WARNING Sterile-w2</b></p> <p>Sterile-packed components must be stored in a safe environment and kept out of direct sunlight. Large temperature changes during storage may cause condensation and violate the integrity of the packaging.</p>
---	---

The sterile-packed needle guide must be stored at a temperature range from +5°C (+41°F) to +25°C (+77°F) and a storage humidity of 0% to 80%.

	<p><b>WARNING D-w1</b></p> <p>For disposal of contaminated items such as transducer covers or needle guides or other disposable items, follow disposal control policies established for your office, department, or hospital.</p>
---	---

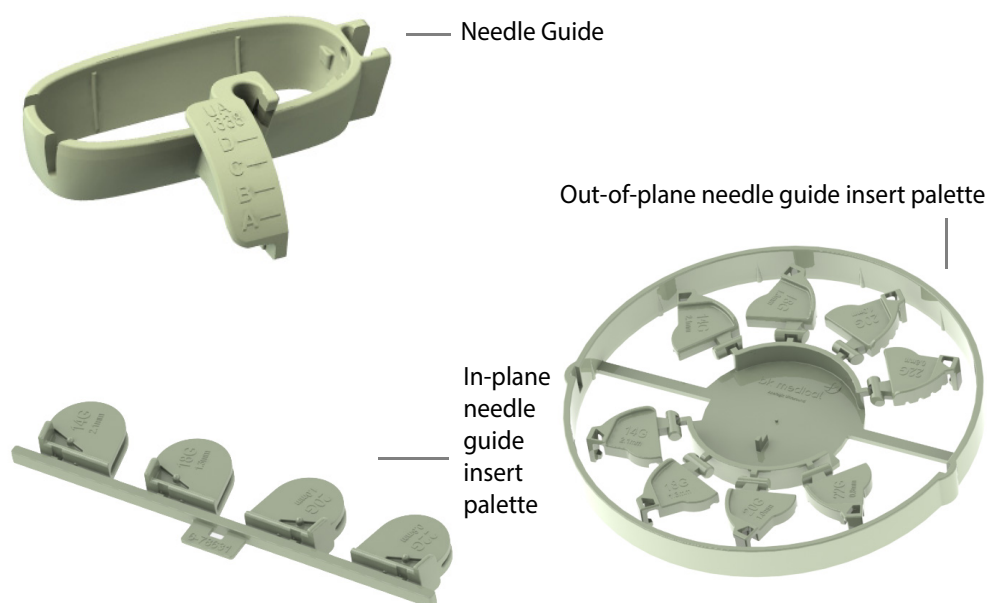

Figure 2. Two needle guide palettes are supplied with needle guide UA1338

Needle guide UA1338 is supplied together with two needle guide insert palettes. Four of the out-of-plane needle guide inserts in the round palette each contain four channels. These channels allow the needle to be positioned at 22.5°, 35°, 47.5° or 60° to the image axis of the 14L3. The remaining four out-of-plane inserts are free-angle and slotted to allow guiding of the needle at any angle between 22.5° and 60°

The in-plane free-angle inserts are slotted to allow guiding of the needle at any angle between approximately 30° and 70° to the image axis of the 14L3 while making sure that the needle follows the plane of the image.

The needle guide inserts are suitable for 14, 18, 20 and 22 gauge needles.

Puncture points instead of puncture lines will be superimposed on the scan image, but the puncture line pattern is shown in Fig. 3.

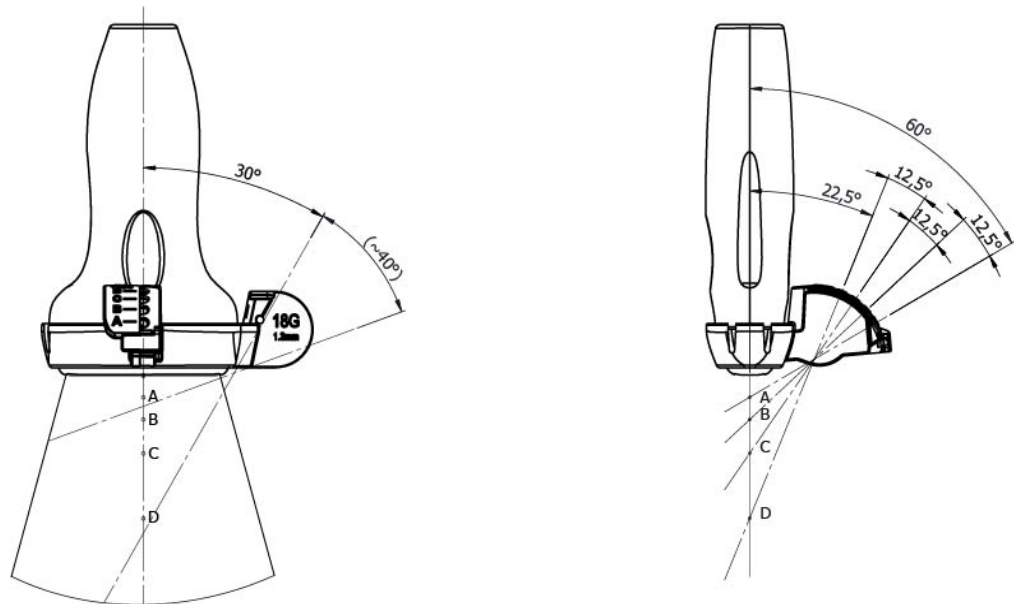



Figure 3. Puncture points for UA1338 on 14L3, using the in-plane and out-of-plane needle guides respectively.

	<p><b>WARNING P-w10a</b></p> <p>The transducer cannot monitor the first part of the puncture line (the length depends on the angle, but for the out-of-plane needle guide, it is up to 4 cm). To avoid harming the patient, scan the tissue that the needle must pass through carefully before insertion. Extra care should be taken during insertion until the needle tip echo can be seen on the image.</p>
	<p><b>WARNING P-w13</b></p> <p>To avoid harming the patient, always be certain which needle guide plane you are using. The out-of-plane needle guide is guided by puncture points displayed on the monitor. There is no expected needle path displayed for the in-plane free angle needle guide.</p>

## Assembling and Mounting the Needle Guide

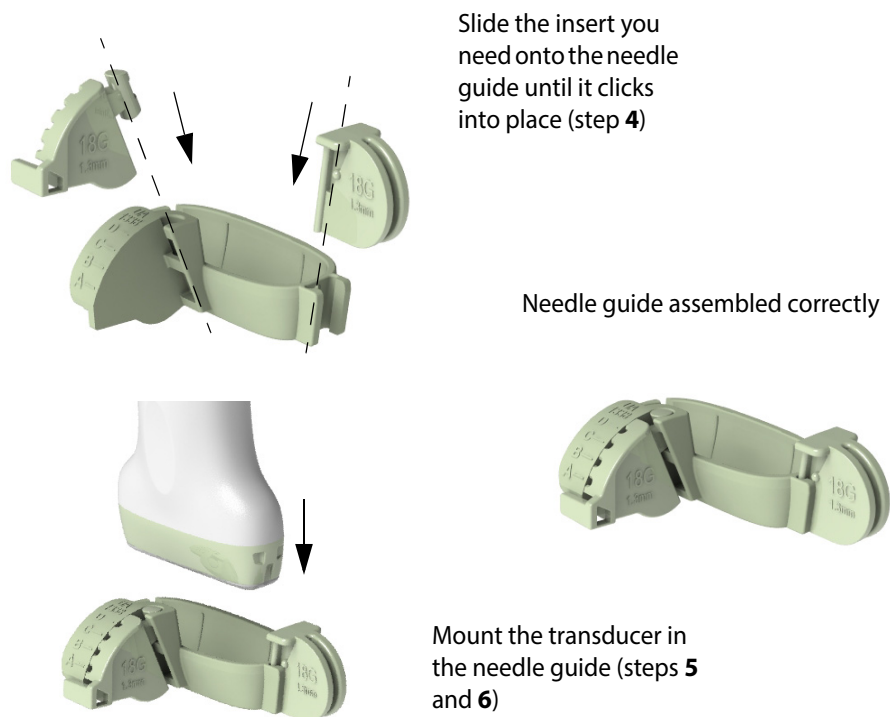

Figure 4. Needle guide UA1338 for 14L3; the numbered steps refer to the steps in the procedure describing how to mount the needle guide below.

### To assemble and mount a needle guide on 14L3:

- 1 Apply a small amount of scanning gel to the tip of the transducer and carefully cover the transducer with a sterile cover.
- 2 For out-of-plane use, select the required out-of-plane needle guide insert by breaking it off the palette, see Fig. 2.
- 3 For in-plane use, select the required in-plane needle guide insert by breaking it off the palette, see Fig. 2
- 4 Slide the insert onto the needle guide until it clicks into place.
- 5 Fit the indentations on the transducer into the two raised knobs on the needle guide. The out-of-plane needle guide must be on the opposite side of the transducer button.
- 6 Carefully smooth and stretch the transducer cover along the face of the array while applying pressure until the needle guide clicks into place over the end of the transducer.
- 7 Fig. 5 shows the needle guide mounted on the transducer.

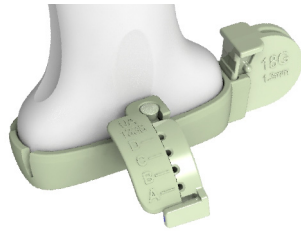





Figure 5. UA1338 mounted on 14L3 (shown here without transducer cover).

**8** Carefully insert the needle into the needle channel.

	<p><b>Caution P-c1</b></p> <p>To avoid contamination, do not let the needle scrape the inside of the needle channel.</p>
---	--

## Performing Puncture and Biopsy

	<p><b>WARNING P-w1</b></p> <p>Before you start imaging, verify that the type number or name of the transducer and the type number or description of the needle guide you are using match the number displayed on the monitor. Also make sure that the needle guide is positioned correctly. If the numbers do not match, or if the needle guide position is not correct, the puncture line on the monitor may not correspond to the true puncture path in the tissue. In case of any inconsistency, stop imaging, turn off the system, and contact your BK service representative.</p>
---	--

	<p><b>WARNING P-w6</b></p> <p>The puncture line on the image is an indication of the expected needle path. To avoid harming the patient, the needle tip echo should be monitored at all times so any deviation from the desired path can be corrected. You must take extra care when taking a freeangle biopsy because the expected needle path is not shown.</p>
---	---

If not sterilized, cover the transducer with a sterile transducer cover.

If the transducer cover is damaged when attaching the puncture attachment, replace it with a new cover.

See the **Product Data Sheet** for a list of available transducer covers.

Superimpose  
puncture  
points

Press the **Puncture Guide** button on the system to superimpose puncture points on the scan image. These points match the needle channel markers A, B, C and D on the out-of-plane needle guide. See Fig. 2.

Move the transducer until the puncture point transects the target. Insert the needle and monitor very carefully as it moves along to the target. The needle tip echo will be seen as a bright dot on the screen.

	<p><b>WARNING TC-w4</b></p> <p>If you detach the needle guide during interventional procedures, the transducer cover could be damaged. To avoid cross-contamination, cover the transducer with a new transducer cover before reattaching the needle guide.</p>
---	--

To remove the puncture point from the scan image, refer to the applicable system user guide for instructions.

	<p><b>WARNING P-w5</b></p> <p>Avoid unnecessary tissue damage. When performing a biopsy, always make sure that the needle is fully drawn back inside the needle guide before moving the transducer.</p>
---	---

## Releasing the Needle During Biopsy

You can release the needle during biopsy so that the needle guide and transducer can be removed from the patient, leaving only the needle in place.

For the out-of-plane needle guide, carefully push the needle guide insert sideways until it opens up, see Fig. 6. Carefully move the transducer and needle guide away from the needle.

For the in-plane, free-angle needle guide, carefully remove the transducer from the needle.

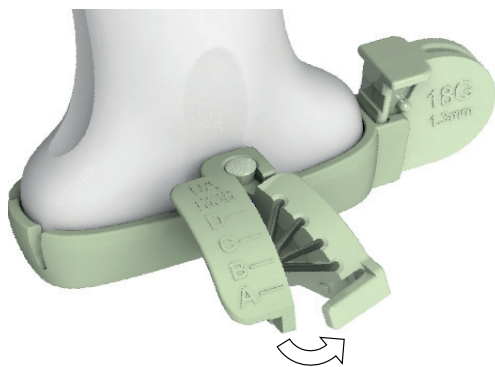



Figure 6. Release the needle from the out-of-plane needle guide by opening it and removing the transducer and needle guide from the needle.

## Cleaning after Puncture and Biopsy

	<p><b>WARNING Reproc-w3</b></p> <p>Immediately after use, you must pre-clean the device until visually clean (including device lumens if existing). Conduct the thorough cleaning process as soon as possible after use in order to prevent bioburden drying on the surface. Dried bioburden can lead to inefficient cleaning, disinfection and sterilization, causing a risk of cross-contamination.</p>
---	---

Use a suitable brush to make sure that biological material and gel are removed from all channels and grooves. See *Care and Cleaning* for cleaning instructions.

## Disposal

When the transducer is scrapped at the end of its life, national rules for the relevant material in each individual land must be followed. Within the EU, when you discard the transducer, you must send it to appropriate facilities for recovery and recycling.

	<p><b>WARNING</b> D-w1</p> <p>For disposal of contaminated items such as transducer covers or needle guides or other disposable items, follow disposal control policies established for your office, department or hospital.</p>
---	--



 BK Medical ApS, Mileparken 34, 2730 Herlev, Denmark. T +45 4452 8100 F +45 4452 8199



**BK Medical**  
8 Centennial Drive  
Peabody  
MA01960  
USA  
T + 1 978-326-1300  
bkmedical.com

**USA**  
**Sales & Service**  
BK Medical  
8 Centennial Drive  
Peabody  
MA01960  
USA  
T + 1 978-326-1300  
F + 1 978-326-1399  
bkmedical.com

**Europe and Rest of World**  
**Sales, Service & Design Center**  
BK Medical  
Mileparken 34  
2730 Herlev  
Denmark  
T +45 4452 8100  
F +45 4452 8199  
bkmedical.com